

Elbow Barbed Connectors

Specification & Drawing Sheet 1 (last updated Oct 2010)

Please click <http://www.williamson-shop.co.uk/elbow-barbed-connectors-6246-p.asp> to place an order via our online shop or please contact us for any requirements not listed or to place an order over the phone.

Part No MICRO 4 ELBOW (Polypropylene 4 mm barbed elbow connector)

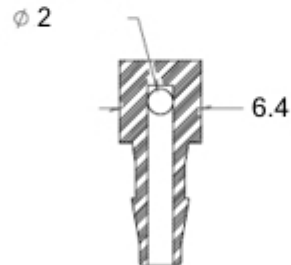
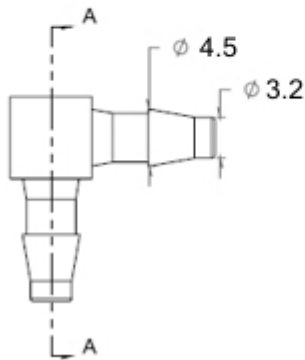
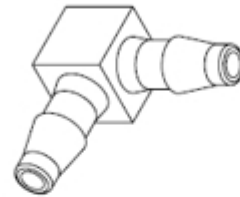
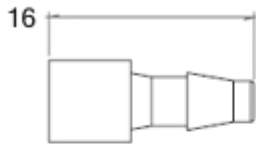

SECTION A-A

All Dimensions in millimetres

Part No MICRO 4.4 ELBOW (Polypropylene 4.4 mm barbed elbow connector)

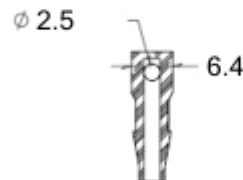
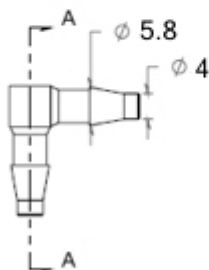
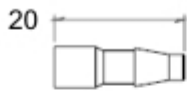

SECTION A-A
SCALE 1 : 1

All Dimensions in millimetres

The Williamson Manufacturing Company Ltd provides no warranty on usage of pumps. We recommend that life tests be carried out prior to use. This information is given in good faith and believed to be correct and current at time of publishing. The Williamson Manufacturing Company Ltd cannot accept responsibility for its inaccuracy or any errors or omissions contained herein. Copyright The Williamson Manufacturing Company Ltd 2008

Elbow Barbed Connectors

Specification & Drawing Sheet 2 (last updated Oct 2010)

Part No MICRO 5 ELBOW (Polypropylene 5 mm barbed elbow connector)

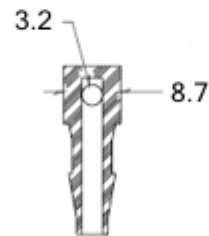
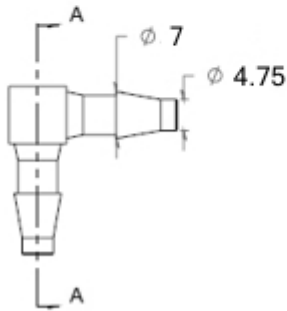
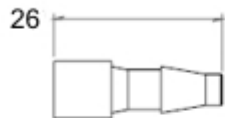

SECTION A-A
SCALE 1 : 1

All Dimensions in millimetres

The Williamson Manufacturing Company Ltd provides no warranty on usage of pumps. We recommend that life tests be carried out prior to use. This information is given in good faith and believed to be correct and current at time of publishing. The Williamson Manufacturing Company Ltd cannot accept responsibility for its inaccuracy or any errors or omissions contained herein. Copyright The Williamson Manufacturing Company Ltd 2008